



FRÁRENNSLISRENNUR OG NIÐURFÖLL



Nicoll

by aliaxis

CLASS A15 - Ætlað fyrir fótgangandi og hjólreiðaumferð



Renna

Vörunúmer	Gerð	Stærð mm	Lengd
CABS773	Grá m/vatnslás	128x54,5	50 cm



Renna

Vörunúmer	Gerð	Stærð mm	Lengd
CAB773	Grá renna	128x54,5	50 cm



Renna

Vörunúmer	Gerð	Stærð mm	Lengd
CAB134	Grá renna	128x54,5	4 m



Renna

Vörunúmer	Gerð	Stærð mm	Lengd
CAN177	PP grár	115x134 mm	1 m
CAN177N	PP Svart	115x134 mm	1 m



Rist - v/CABS773 - CAB773

Vörunúmer	Gerð	Stærð mm	Lengd
GRL77	PVC	128x54,5	50 cm



Rist

Vörunúmer	Gerð	Stærð mm	Lengd
GR77PB	Hvtt gólfrenna	128x54,5	50 cm
GRL77	PVC	128x54,5	50 cm



Rist

Vörunúmer	Gerð	Stærð mm	Lengd
GDR10AHP	Svart Polyam	128x54,5	50 cm



Rist

Vörunúmer	Gerð	Stærð mm	Lengd
GDR10ATI	Ryðfrí gólfrenna	128x54,5	1 cm
GDR10AP	Galv. gólfrenna	128x54,5	1 cm

CLASS B125 - Ætlað fyrir fótgangandi, einkabílastæði eða minni bílaumferð



Renna PP

Vörunúmer	Gerð	Stærð mm	Lengd
CAN10BN	Polyam grind	115-136	1 m



Renna PP

Vörunúmer	Gerð	Stærð mm	Lengd
CAL10BF	Pott grind svört	103-136	1 m



Renna PP

Vörunúmer	Gerð	Stærð mm	Lengd
CAN10BCI	Ryðfrí grind	115-136	1 m



Rist - v/CABS773 - CAB773 - CAB773

Vörunúmer	Gerð	Stærð mm	Lengd
GR77	PVC	128x54,5	50 cm

CLASS C250 - Ætlað fyrir svæði með léttari bílaumferð



Renna PP

Vörunúmer	Gerð	Stærð mm	Lengd
DR102CN	Polyam grind - svört	170x136	1 m



Renna PP

Vörunúmer	Gerð	Stærð mm	Lengd
DR102CF	Pott grind svört	170x136	1 m



Renna PP

Vörunúmer	Gerð	Stærð mm	Lengd
DR100CN	Polyam grind svört	80x136	1 m



Renna PP

Vörunúmer	Gerð	Stærð mm	Lengd
DR100CF	Pott grind svört	80x136	1 m

CLASS E400

Ætlað fyrir hraðbrautir, bílastæði og öll ökutæki.



Renna

Vörunúmer	Gerð	Stærð mm	Lengd
DR202DF	Pott grind svört	237x249	1 m



Renna

Vörunúmer	Gerð	Stærð mm	Lengd
DR102DF	Pott grind svört	170x136	1 m

CLASS E600 -

Ætlað fyrir svæði með mikilli umferð, t.d. iðnaðarplön eða hafnarsvæði.



Renna PP

Vörunúmer	Gerð	Stærð mm	Lengd
DR102EF	Pott grind svört	170x136	1 m



Renna PP

Vörunúmer	Gerð	Stærð mm	Lengd
DR302EF	Pott grind svört	369x361	1 m

Samtengi



Samtengi

Vörunúmer	Gerð	Stærð mm
NAH773	fyrir CAB133A rennur	128x54,4 mm

Rennuendar



Rennuendi

Vörunúmer	Gerð	Stærð mm
NAH773	fyrir CAB773 rennu eða CABS773 m/vatnslás	40 mm 54,5x128 mm



Rennuendi

Vörunúmer	Gerð	Stærð mm
NJDR100	fyrir DR100CN rennu	50 mm 80x136 mm



Rennuendi

Vörunúmer	Gerð	Stærð mm
NAV178	fyrir CAL10BF rennu	110 mm



Rennuendi

Vörunúmer	Gerð	Stærð mm
NAV177N	Svart - fyrir CAN10BN	110 mm
NAV177	Grátt - fyrir CAN10B	110 mm



Rennuendi

Vörunúmer	Gerð	Stærð mm
NVDR102	fyrir DR102CN rennu	110 mm 170x136 mm



Rennuendi

Vörunúmer	Gerð	Stærð mm
NZDR202	fyrir 160 mm	170x136 mm



Botn úrtak

Vörunúmer	Gerð	Stærð mm
SBDR20	fyrir DR202CF rennu	200 mm 237x249 mm



Lóðrétt úrtak

Vörunúmer	Gerð	Stærð mm
STCAB13	fyrir CAL10BF CAN177 / CAN10BN CAL10BF / DRP178	110 mm



Lóðrétt úrtak

Vörunúmer	Gerð	Stærð mm
SVCAN	fyrir CAL10BF CAN177 / CAN10BN CAL10BF / DRP178	110 mm



Vatnslás

Vörunúmer	Gerð	Stærð mm
SSVCAN	f/CAN10BN	40/50 - 110 mm



Vatnslás

Vörunúmer	Gerð	Stærð mm
SSVCAB13	f/CAB133A	40/50 - 110 mm

Niðurföll



Sandfang

Vörunúmer	Gerð	Stærð mm
PSCVV	Sandfang	110 mm



Niðurfall

Vörunúmer	Gerð	mm	Ø
SCP1110	m/vatnslás	20x20	110mm



Niðurfall

Vörunúmer	Gerð	mm	Ø
SC456G	m/vatnslás - ljós grátt	150x150	50
SC456	m/vatnslás - svart	150x150	50



Niðurfall

Vörunúmer	Gerð	mm	Ø
SK1110G	m/vatnslás - ljós grátt	250x250	110
SK1110	m/vatnslás - svart	250x250	110



Vatnslás

Vörunúmer	Gerð	Stærð mm
YV1	Vatnslás	110 mm

Aukahlutir



Skrúfusettt v/CAB rennur

Vörunúmer	Gerð
FIXCAB13	Galv. skrófusettt v/CAB rennur



Skrúfur v/CAN ristum

Vörunúmer	Gerð	Magn
FIXCAN	skrófur fyrir CAN ristum	12 stk

CLASS A15 - Ætlað fyrir frárennsli á svölum og sundlaugar ofl.

CONNECTO®



CAB133A
Renna dökk grá - 128x54,5 - 3 m

NAHJ13
Enda úttak v/rennu - 50 mm

GDR10AP
Rist v/CAB rennur
Galvaniserað stál

GDR10AHPP
Rist v/CAB rennur
Svart Polyam

GDR10ATI
Rist v/CAB rennur
Ryðfrí gólfrenna

PVC

Litr

GRL77 / GRL77S / GRL77K

GR77P / GR77PS / GR77PB

STCAB13
Lóðrétt úrtak - 110 mm

JCAB13
samtengi v/CAB rennur
- 128x54,5 mm

FIXCAB13
Skrúfuset v/CAB rennur

SSVCAB13
Vatnssál - 40/50 - 110 mm

PSCVV
Enda úttak
sandfang
110 mm

32
54,5

CLASS A15 - Ætlað fyrir fótgangandi og hjólréiðumferð

CONNECTO®



CABS773 / CABS773S
Renna m/vatnslás 128x54,5 mm - 50 cm

CAB773 / CAB773S
Renna 128x54,5 mm - 50 cm

GR77P / GR77PS / GR77PB
PVC rist - 128x54,5 - 50 cm

CAN177
Gólfrennur
115x134 mm, 1 m.

GDR10AP
Rist v/CAB rennur
Galvaniserað stál

GDR10AHPP
Rist v/CAB rennur
Svart Polyam

GDR10ATI
Rist v/CAB rennur
Ryðfrí gólfrenna

FIXCAN
Skrúfuset v/CAB rennur skrúfur
fyrir CAN ristum, 12 stk

SVCAN
Enda úttak 110 mm

NAH773
Rennuendi v/CAB773 rennu - 40 mm

GRL77 / GRL77S / GRL77K
PVC rist - 128x54,5 - 50 cm

PSCVV
Enda úttak
sandfang
110 mm

110
128

CLASS B125 - Ætlað fyrir fótgangandi, einkabílastæði eða minni bílaumferð

CONNECTO®



CAN10BN
Renna PP 115-136 mm - 1 m
Polyamide grind

NAV178
Enda úttak - fyrir CAL10BF / CAN10BN - 110 mm

CAL10BF
Renna PP 115-136 mm - 1 m
Ryðfrítt stál

GR77
Rist fyrir CABS773 / CAB773 / CAN10BN rennur
50 cm - PVC

NAV177 / NAV177N
Enda úttak - fyrir CAN177 - 110 mm
Grá eða svart

SVCAN
Lóðrétt úrtak fyrir
CAN177 / CAN10BN /
CAL10BF / DRP178 - 110 mm

SSVCAN
Vatnssál - 40/50 - 110 mm

PSCVV
Enda úttak
sandfang
110 mm

83
115
136

CLASS C250 - Ætlað fyrir svæði með léttri bílaumferð

KENADRAIN®

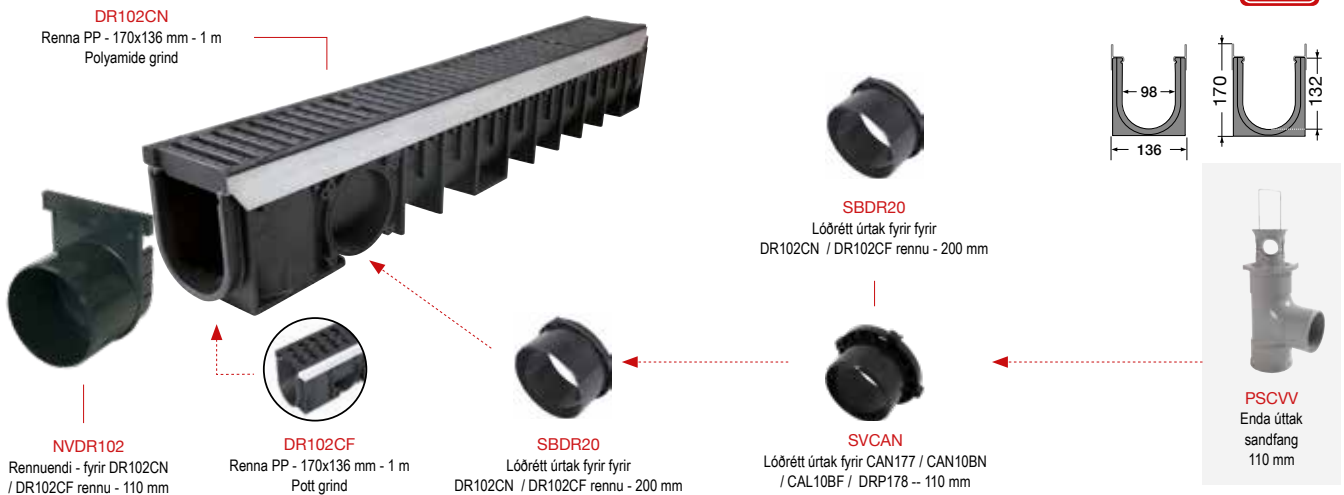

CLASS C250 - Ætlað fyrir svæði með léttri bílaumferð

KENADRAIN®

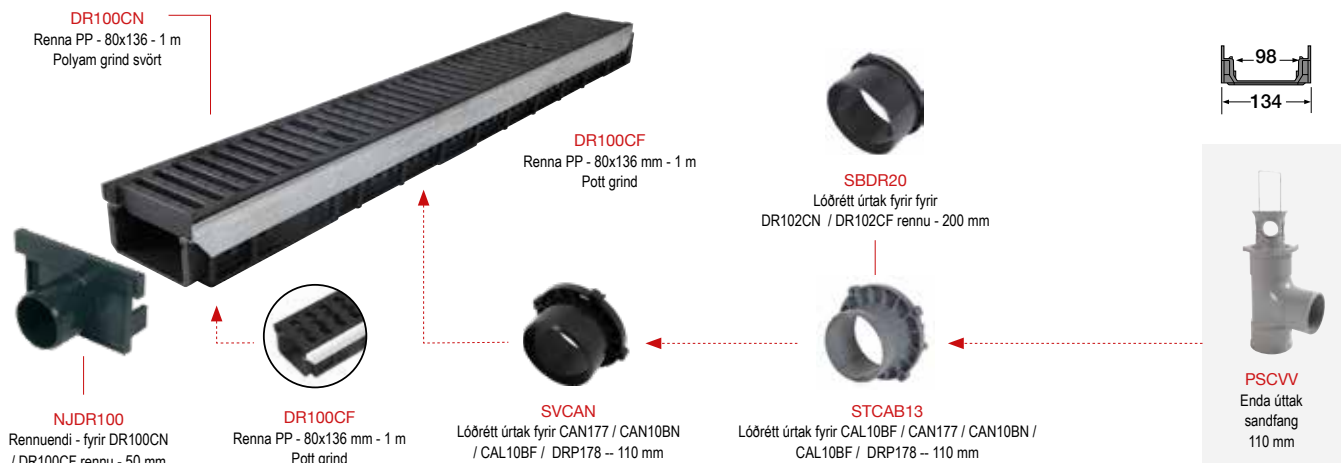

CLASS E400 - Ætlað fyrir hraðbrautir, bílastæði og öll ökutæki.

KENADRAIN®

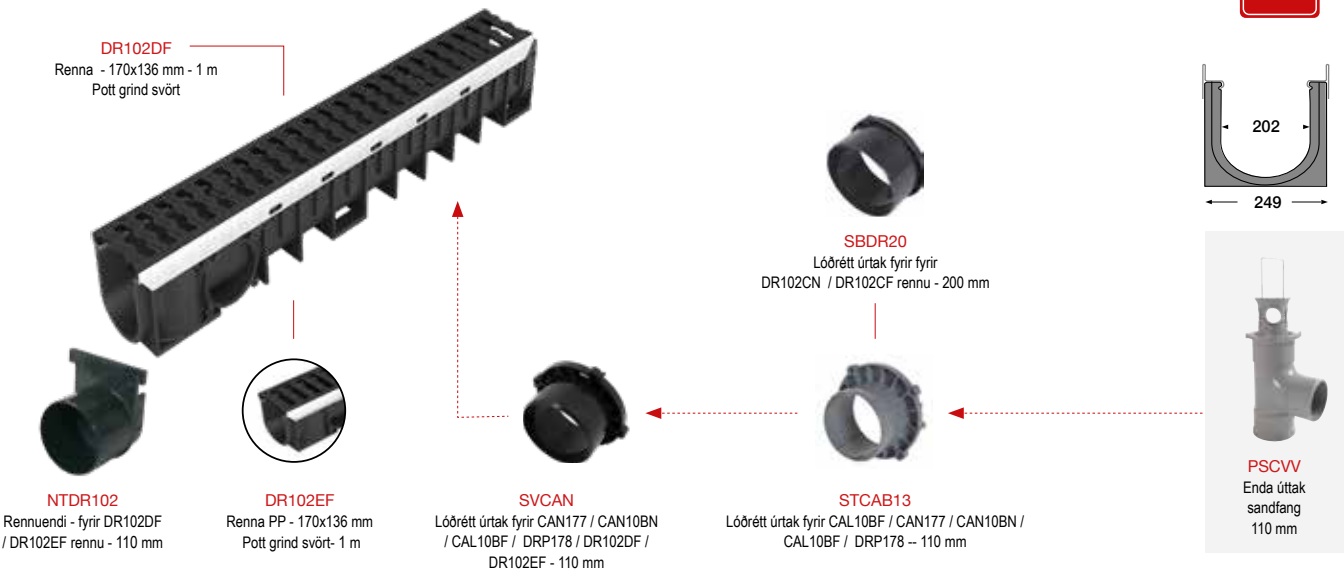

CLASS E600 - Ætlað fyrir svæði með mikilli umferð, t.d. iðnaðarplön eða hafnarsvæði.

KENADRAIN®

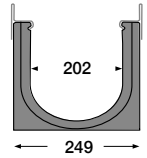

Margar gerðir og lausnir og einfalt í uppsetningu - Fellur vel inn í umhverfið - Sterkt og þolir mikila umferð á iðnaðarplönum

CONNECTO®



Fyrir einkabílastæði og garða



KENADRAIN®



Fyrir þéttbýli og opinbert svæði

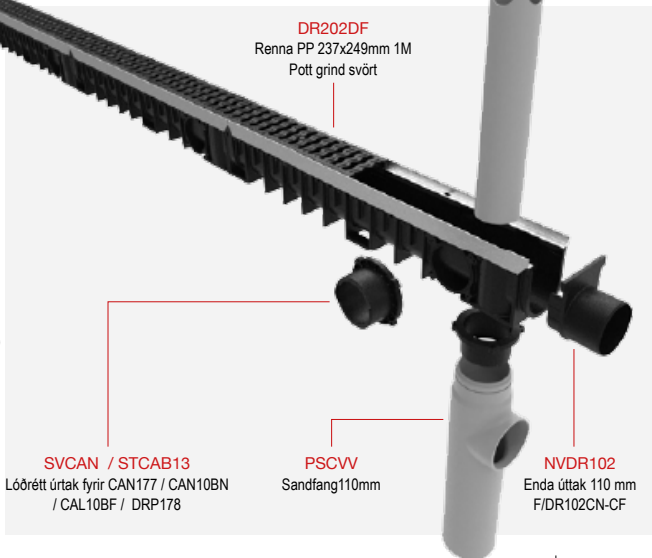

► FORM

Kassalagað

► HÆÐ

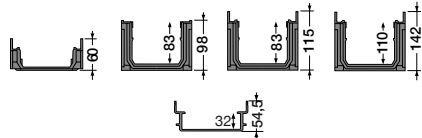

► BREIDD

Int.	100	100	100	150
Ext.	130	130	130	200

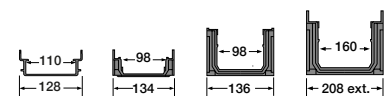

► LENGD



► LITIR



► FORM

U-lagað

► HÆÐ

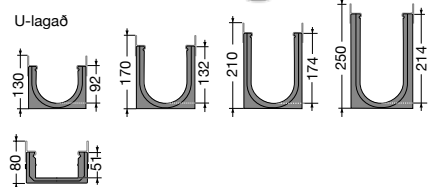

► BREIDD

Int.	100	150	200	300
------	-----	-----	-----	-----

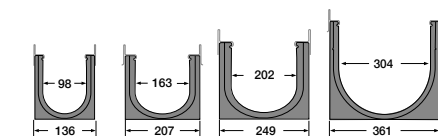

► LENGD

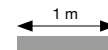

► LITIR





LOFT&RAFTÆKI



Vatnsorka



Taktu mynd af QR kóðanum og skoðaðu **Handbók 2026** í símanum



LOFT&RAFTÆKI
loft.is



Vatnsorka
vatnsorka.is



Hjallabrekka 1 - Dalbrekkumegin | 200 Kópavogur | S: 564 3000